

# FORMED / concrete basins

---

## Akin (Akin A2)

### Product Image

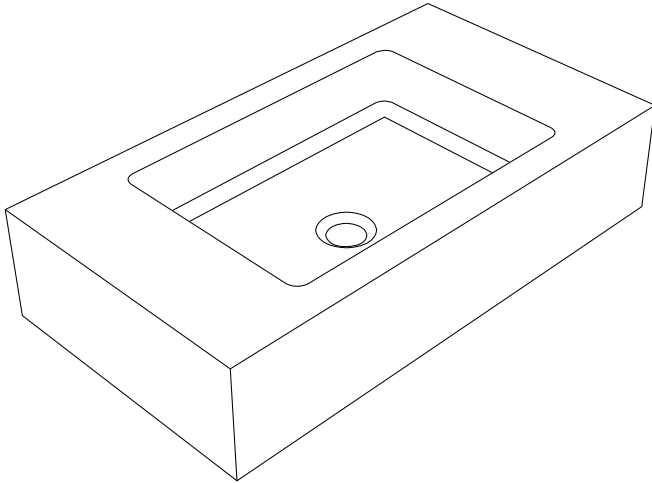

### Product Description

- ◆ Exterior dimensions 640x350x140mm.
- ◆ Bowl 400x270x100mm.
- ◆ Walls 40mm.
- ◆ Wall or surface mounted.
- ◆ Available with or without wall brackets.
- ◆ Suitable for wall mounted tap.
- ◆ Brackets to be securely fixed to suitable support wall.
- ◆ Brackets to be set 15-20mm behind finished wall surface.
- ◆ Custom steel vanity frames available.
- ◆ Weight 50 kg

### Finishes Available

Available in our full range of colours.

---

### Technical Drawing

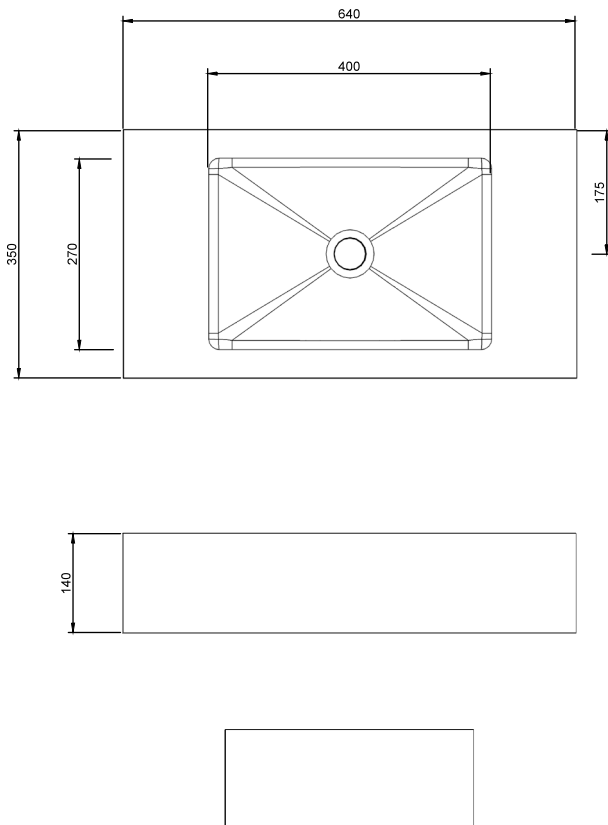

### Product Care

- ◆ Our finishes can be delicate and require both drying after use as well as careful & regular cleaning routines.
- ◆ Normal cleaning should only be done with mild liquid soap in warm water, applied with a soft cloth
- ◆ Mineral build-up can be removed with warm water, applied with a microfibre cloth and then rinsed.
- ◆ Periodic application of wax or polish will help reduce mineral based standing water marks.
- ◆ Cleaning products containing bleach or solvents should NOT be used as this can permanently discolour the concrete and damage the sealant.
- ◆ Abrasive cleaning materials should NOT be used.
- ◆ Periodically apply polish/wax as specified in the care instructions to maintain appearance.
- ◆ Alternatively the surface can be re-oiled in place of periodic wax / polish applications using our Eco-Sealant based on plants and vegetable oils. Contact us to discuss your requirements.